

# BELLATERRA HOME

**Model: 400503 (Counter top sold separately)**

## Tools List (Not included)

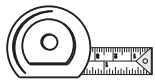

Tape Measure



Pencil



Electric Drill



Drill Bit

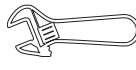

Adjustable wrench



Spirit Level

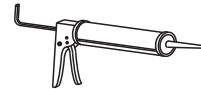

Silicone

## Parts List (Included)

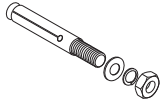

Expansion bolt  
(2sets)

Mark the position of the screw holes on the wall by measuring the space between the mounting brackets on the back of the vanity. Vertical position (X) is decided by the user, remember to mark low enough to accommodate the sink on the top of the vanity counter or it will be too high when installed. Use a spirit level to ensure the screws holes are in line.

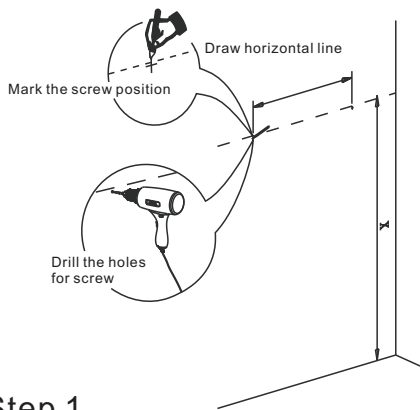

Step 1

Insert the expansion bolts into the pre-drilled holes, then put on the washers and the nut, and use the adjustable wrench to tighten the nut in order to expand the bolt inside the wall. Loose the nut and washers once the bolts fixed inside the wall. Remember to keep out 0.5" of the thread for hanging the cabinet on.

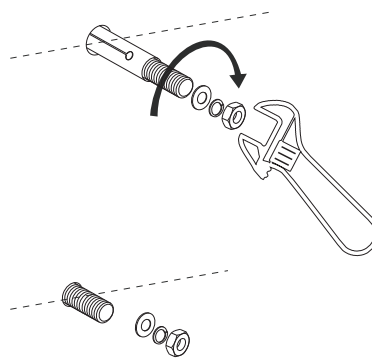

Step 2

Attach the vanity to the wall by lowering the bracket onto the screws.

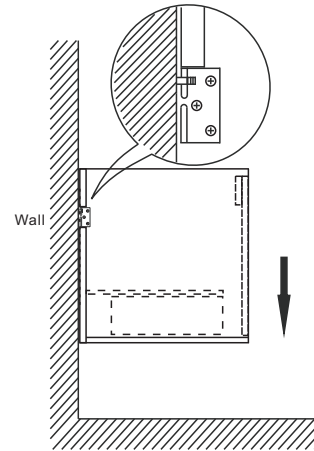

Step 3

Use a spirit level to ensure the vanity is level from left to right and front to back, adjust if needed.

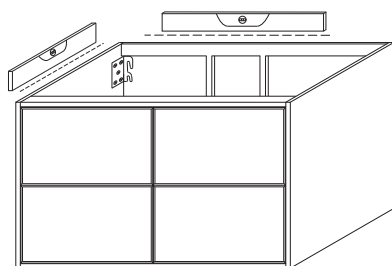

Step 4

Put the countertop on the top of vanity, and check if it stay firm on the vanity.

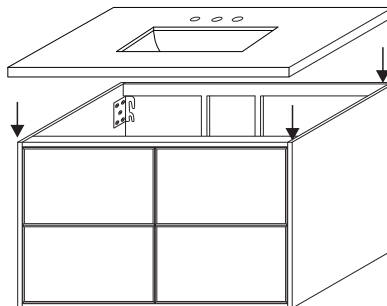

Step 5

Finally, place the ceramic sink again to check the stability.

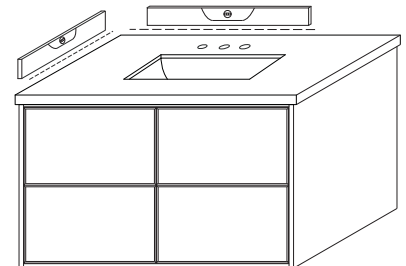

Step 6

## INSTALLATION TIPS:

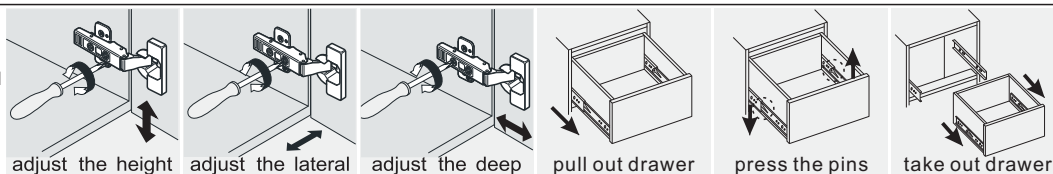

**NOTE: SINK STYLE, SHAPE, FAUCET HOLES, CUTOUT ON TOP, VANITY MAY VARY FROM THE PICTURE ABOVE. INSTRUCTIONAL PURPOSE ONLY.**